



Lithium-Ion Cell - LI21700JD-40P Power Type

- High Discharge Current
- Long Cycle Life
- Low Self-Discharge
- Fast Charging Capability



SPECIFICATIONS	
Jauch Part Number	252386
Nominal Voltage	3.7 V
Charging Voltage	4.2 V
Nominal Capacity	4000 mAh
Standard Discharge Current	20 A (@ ambient temp.)
Max. Discharge Current (cont.)	45 A (80°C temperature cut)
Standard Charge Current	4.0 A
Max. Charge Current (cont.)	6.0 A
Discharge Ending Voltage	2.5 V
Standard Charge cut-off current	80 mA
Internal Resistance	≤12 mΩ (ACIR)
Weight	Approx. 70 g
Operating Temperature Charge	0°C to +60°C
Operating Temp. Discharge	-20°C to +80°C
UL1642	MH62838

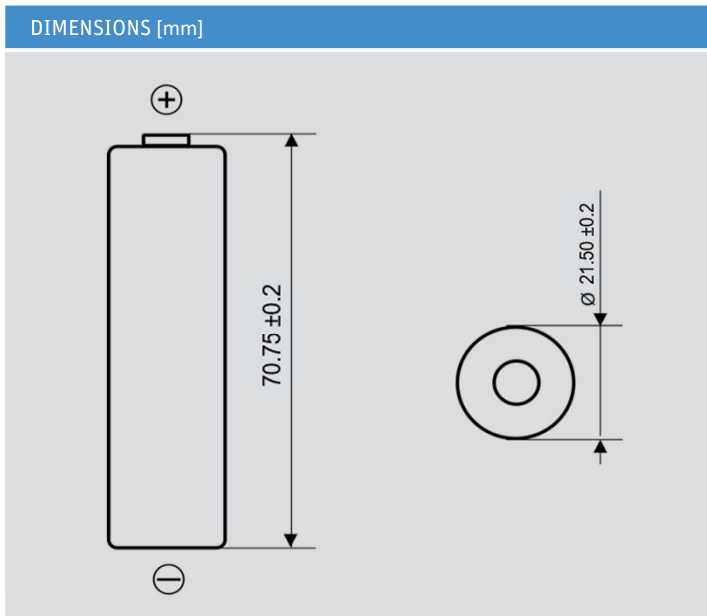

For full specifications, please contact batterytechnology@jauch.com.

