



Lithium Coin Cell - CR 2450 SM

- Low self-discharge
- Long shelf life
- UN 38.3 tested
- Wide assortment of mounting options and wire terminals available



RoHS compliant



Pb free



REACH compliant



Conflict mineral free

SPECIFICATIONS

Jauch part number	249441
Nominal Voltage	3V
Nominal Capacity	610 mAh
Standard Load	7.5 kΩ
Standard Current	0.4 mA
Max. Continuous Current	4 mA
Max. Pulse Current	15 mA
Operating Temperature	-30°C to +85°C *
Weight	Approx. 6.7 g
Chemistry	Li/MnO ₂

Note: Lithium batteries are not suitable for reflow soldering processes

Note: Capacity 610mAh is obtained at standard cc load to 2.0V at 23°C.

DIMENSIONS [mm]

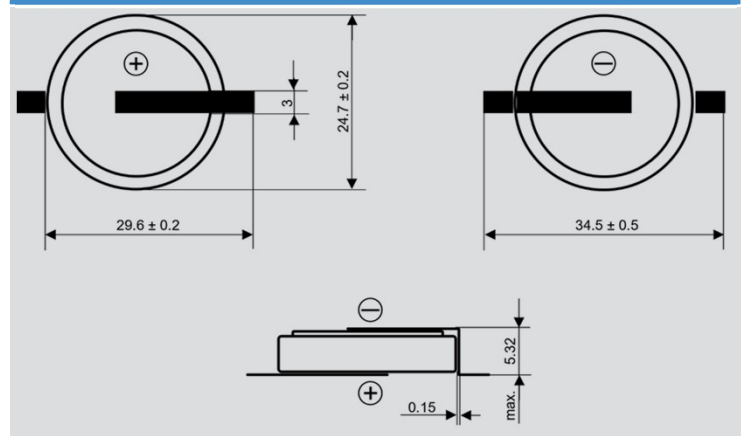

* In applications where the battery is exposed to temperatures >60°C, please contact Jauch.

DISCHARGE CHARACTERISTICS

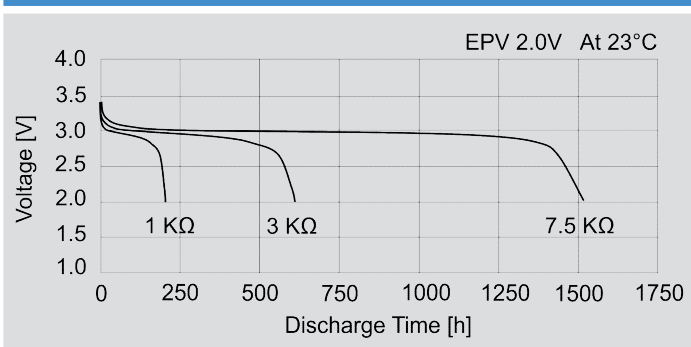

TEMPERATURE CHARACTERISTICS

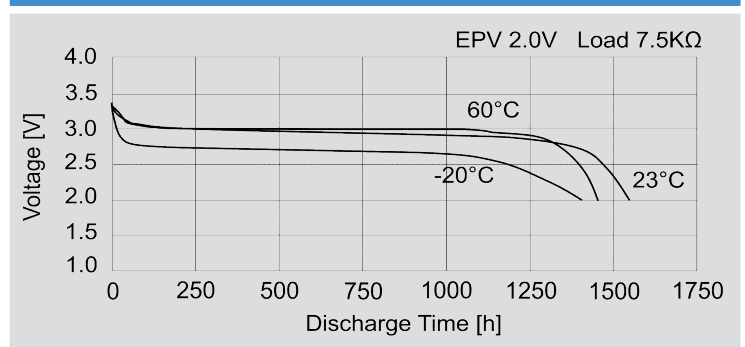

DISCHARGE CHARACTERISTICS

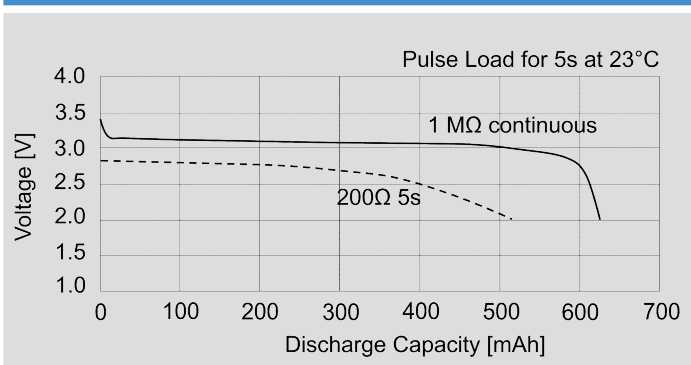

LOAD VS: CAPACITY

