

FEATURES

- EXPANDED VALUE RANGE & REDUCED CASE SIZES
- MOLDED CONSTRUCTION FOR HIGH SOLDERING HEAT RESISTANCE
- ELEVEN CASE SIZES (P, A2, A, B2, B, C2, C, V, D AND E)
- BOTH FLOW AND REFLOW SOLDERING APPLICABLE
- TAPE & REEL PACKAGING COMPATIBLE WITH AUTOMATIC PICK & PLACE EQUIPMENT

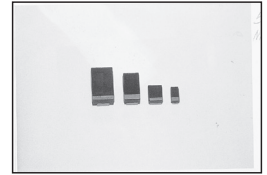

RoHS Compliant
includes all homogeneous materials

*See Part Number System for Details

SPECIFICATIONS & PERFORMANCE CHARACTERISTICS

Capacitance Range	0.1μF to 470μF								
Capacitance Tolerance	±10% (K), ±20% (M)								
Rated Voltage Range @ 85°C (Vdc)	2.5	4.0	6.3	10	16	20	25	35	50
Surge Voltage Rating @ 85°C (Vdc)	3.3	5.2	8.0	13	20	28	33	46	85
Derated Voltage @ 125°C (Vdc)	1.8	2.5	4.0	6.3	10	13	16	22	32
Operating Temperature Range	-55°C to +125°C (voltage derating at temperatures over +85°C as referenced above)								
Dissipation Factor	See Case Size and Specifications Table								
Leakage Current @ +25°C (After 5 Minutes at Rated Voltage)	Not More Than 0.01CV or 0.5μA, whichever is greater								
Capacitance Change With Temperature	-55°C			+85°C			+125°C		
A2, A, B2, B, C, D & E Case Size	ΔC - 12%			ΔC ± 12%			ΔC ± 12%		
J & P Case Size	ΔC - 20%			ΔC ± 20%			ΔC ± 20%		
Resistance to Soldering Heat (+260°C for 5 Seconds)	ΔC ± 5%* Max, LC = Less than initial specification. DF = Less than initial specification								
Moisture Resistance (500 hours; 90~95% RH @ 40°C)	ΔC ± 5%* Max, LC = Less than initial specification. DF = 150% of initial specification								
Temperature Cycling (5 cycles; -55°C ~ +125°C)	ΔC ± 5%* Max, LC = Less than initial specification. DF = Less than initial specification								
Load Life (at Rated Voltage) (2,000 hours @ 85°C)	ΔC ± 10%* Max, LC = 125% of initial specification. DF = Less than initial specification								
Base Failure Rate (1.0Ω/Volt)	1%/1000 hours at 60% confidence level (+85°C)								

*±12% ~ ±15% for extended values, ±20% for P case size values

RIPPLE CURRENT CORRECTION FACTOR:

Ambient Temperature	25°C	+55°C	+85°C	+105°C	+125°C
Correction Factor	1.0	0.90	0.80	0.40	0.15

RIPPLE CURRENT/VOLTAGE RATINGS:

$$I_{max.} = \sqrt{\frac{P_d}{ESR}} \quad V_{max.} = Z \cdot \sqrt{\frac{P_d}{ESR}}$$

I_{max.} = Ripple Current rating (Arms)

P_d = Power dissipation (watt)

ESR = Equivalent series resistance (ohm)

V_{max.} = Ripple voltage rating (Vrms)

$$Z = \text{The capacitors impedance (ohm)} = \sqrt{(ESR)^2 + (XL - XC)^2}$$

POWER DISSIPATION @ 25°C (FREE AIR) & EQUIVALENT SERIES INDUCTANCE (ESL)

Case Code	Pd Max. (W)	ESL (nH)
P	0.025	1.00
A2	0.050	1.20
A	0.070	1.20
B2	0.070	1.50
B	0.080	1.50
C2	0.090	-
C	0.110	2.70
V	0.125	-
D	0.150	3.00
E	0.165	3.00

PART NUMBER SYSTEM

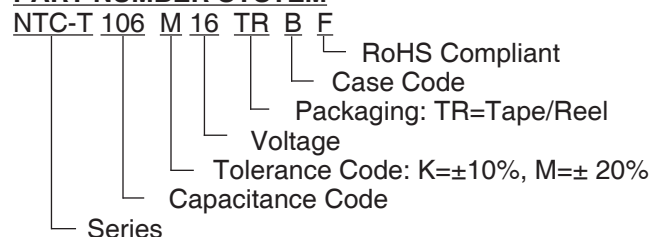

PRECAUTIONS

Please review the notes on correct use, safety and precautions found on our website at www.niccomp.com/tantpc
If in doubt or uncertainty, please review your specific application - process details with NIC's technical support personnel: tpmg@niccomp.com



STANDARD AND EXTENDED PRODUCT SPECIFICATIONS TABLE

*Extended Case Sizes

Part Number	Cap. (µF)	Voltage (Vdc)	Dissipation Factor @ 120Hz/20°C	Leakage Current (µA) @ 20°C	ESR (ohms) @ 100KHz/20°C	Ripple Current Rating (mA) @ 100KHz/25°C
NTC-T475K2.5TRA2F	4.7*	2.5	8%	0.5	18	53
NTC-T685M2.5TRPF	6.8	2.5	20%	0.5	20	35
NTC-T685K2.5TRA2F	6.8*	2.5	8%	0.5	16	56
NTC-T106M2.5TRPF	10	2.5	20%	0.5	12	46
NTC-T106K2.5TRA2F	10*	2.5	8%	0.5	15	58
NTC-T156K2.5TRA2F	15*	2.5	12%	0.5	10	71
NTC-T156K2.5TRAF	15*	2.5	8%	0.5	5.0	118
NTC-T226M2.5TRPF	22	2.5	20%	0.55	4.0	79
NTC-T226K2.5TRA2F	22*	2.5	12%	0.55	10	71
NTC-T226K2.5TRAF	22*	2.5	8%	0.55	4.0	132
NTC-T336M2.5TRPF	33	2.5	20%	0.83	5.0	71
NTC-T336K2.5TRA2F	33	2.5	12%	0.83	4.0	112
NTC-T336K2.5TRAF	33*	2.5	8%	0.83	3.5	141
NTC-T336K2.5TRB2F	33*	2.5	8%	0.83	3.5	141
NTC-T336K2.5TRBF	33*	2.5	8%	0.83	3.0	163
NTC-T476M2.5TRPF	47	2.5	30%	1.18	6.0	65
NTC-T476K2.5TRA2F	47	2.5	12%	1.18	4.5	105
NTC-T476K2.5TRAF	47*	2.5	12%	1.18	4.5	125
NTC-T476K2.5TRB2F	47*	2.5	12%	1.18	4.5	125
NTC-T476K2.5TRBF	47	2.5	8%	1.18	2.4	183
NTC-T686K2.5TRAF	68	2.5	18%	1.7	2.0	187
NTC-T686K2.5TRBF	68	2.5	8%	1.7	2.0	200
NTC-T107K2.5TRAF	100	2.5	30%	2.5	2.0	187
NTC-T107K2.5TRB2F	100	2.5	18%	2.5	2.0	187
NTC-T107K2.5TRBF	100	2.5	8%	2.5	2.0	200
NTC-T157K2.5TRAF	150	2.5	30%	3.75	2.0	187
NTC-T157K2.5TRB2F	150	2.5	20%	3.75	1.0	265
NTC-T157K2.5TRBF	150*	2.5	16%	3.75	5.0	126
NTC-T157K2.5TRC2F	150	2.5	12%	3.75	0.8	335
NTC-T227K2.5TRB2F	220	2.5	30%	5.5	1.0	265
NTC-T227K2.5TRBF	220	2.5	18%	5.5	2.0	200
NTC-T227K2.5TRC2F	220	2.5	12%	5.5	0.8	335
NTC-T227K2.5TRCF	220*	2.5	12%	5.5	1.0	332
NTC-T337K2.5TRB2F	330	2.5	30%	8.25	2.0	187
NTC-T337K2.5TRBF	330	2.5	25%	8.25	0.6	365
NTC-T337K2.5TRCF	330	2.5	16%	8.25	1.2	303
NTC-T477K2.5TRBF	470	2.5	35%	11.75	0.6	365
NTC-T477K2.5TRCF	470	2.5	18%	11.75	1.2	303
NTC-T477K2.5TRDF	470*	2.5	14%	11.75	0.7	463
NTC-T155M4TRPF	1.5	4	10%	0.5	25	32
NTC-T225M4TRPF	2.2	4	10%	0.5	25	32
NTC-T335M4TRPF	3.3	4	20%	0.5	20	35
NTC-T335K4TRA2F	3.3*	4	8%	0.5	18	53
NTC-T335K4TRAF	3.3	4	4%	0.5	8.0	94
NTC-T475M4TRPF	4.7	4	20%	0.5	12	46
NTC-T475K4TRA2F	4.7*	4	8%	0.5	10	71
NTC-T475K4TRAF	4.7	4	4%	0.5	7.5	97
NTC-T685M4TRPF	6.8	4	20%	0.5	12	46
NTC-T685K4TRA2F	6.8*	4	8%	0.5	8.0	79
NTC-T685K4TRAF	6.8*	4	8%	0.5	6.0	108
NTC-T106M4TRPF	10	4	20%	0.5	12	46
NTC-T106K4TRA2F	10*	4	12%	0.5	8.0	79
NTC-T106K4TRAF	10*	4	8%	0.5	5.0	118
NTC-T106K4TRBF	10	4	6%	0.5	3.5	151

Note: 20% (M) tolerance parts available special order



STANDARD AND EXTENDED PRODUCT SPECIFICATIONS TABLE

*Extended Case Sizes

Part Number	Cap. (μF)	Voltage (Vdc)	Dissipation Factor @ 120Hz/20°C	Leakage Current (μA) @ 20°C	ESR (ohms) @ 100KHz/20°C	Ripple Current Rating (mA) @ 100KHz/25°C
NTC-T156M4TRPF	15	4	20%	0.6	5.0	71
NTC-T156K4TRA2F	15*	4	12%	0.6	8.0	79
NTC-T156K4TRAF	15*	4	8%	0.6	4.0	132
NTC-T156K4TRBF	15*	4	8%	0.6	3.0	163
NTC-T226K4TRPF	22	4	20%	0.88	5.0	71
NTC-T226K4TRA2F	22	4	12%	0.88	4.0	112
NTC-T226K4TRAF	22*	4	8%	0.88	3.5	141
NTC-T226K4TRB2F	22*	4	8%	0.88	3.5	141
NTC-T226K4TRBF	22*	4	8%	0.88	2.8	169
NTC-T336M4TRPF	33	4	20%	1.32	4.0	79
NTC-T336K4TRA2F	33	4	8%	1.32	4.5	105
NTC-T336K4TRAF	33*	4	10%	1.32	4.5	39
NTC-T336K4TRB2F	33	4	12%	1.32	4.5	125
NTC-T336K4TRBF	33*	4	8%	1.32	2.4	183
NTC-T476M4TRPF	47	4	30%	1.88	3.0	91
NTC-T476K4TRA2F	47	4	15%	1.88	4.5	105
NTC-T476K4TRAF	47	4	12%	1.88	5.0	118
NTC-T476K4TRB2F	47	4	12%	1.88	3.0	153
NTC-T476K4TRBF	47*	4	8%	1.88	2.4	188
NTC-T476K4TRCF	47*	4	8%	1.88	1.8	247
NTC-T686K4TRAF	68	4	12%	2.72	2.5	167
NTC-T686K4TRB2F	68	4	15%	2.72	3.0	153
NTC-T686K4TRBF	68*	4	8%	2.72	2.0	200
NTC-T686K4TRCF	68*	4	8%	2.72	1.6	262
NTC-T107K4TRAF	100	4	30%	4.0	2.0	187
NTC-T107K4TRB2F	100	4	20%	4.0	1.3	232
NTC-T107K4TRBF	100*	4	12%	4.0	2.0	200
NTC-T107K4TRC2F	100	4	10%	4.0	0.8	335
NTC-T107K4TRCF	100*	4	8%	4.0	1.2	303
NTC-T107K4TRDF	100*	4	8%	4.0	0.8	433
NTC-T157K4TRBF	150	4	18%	6.0	2.0	200
NTC-T157K4TRC2F	150	4	10%	6.0	0.8	335
NTC-T157K4TRCF	150*	4	10%	6.0	1.0	332
NTC-T157K4TRDF	150*	4	8%	6.0	0.7	463
NTC-T227K4TRBF	220	4	18%	8.8	0.5	400
NTC-T227K4TRCF	220	4	12%	8.8	1.2	303
NTC-T227K4TRDF	220*	4	8%	8.8	0.7	463
NTC-T337K4TRCF	330	4	14%	13.2	1.2	303
NTC-T337K4TRVF	330	4	12%	13.2	0.5	500
NTC-T337K4TRDF	330*	4	14%	13.2	0.7	463
NTC-T477K4TRDF	470	4	16%	18.8	1.0	387
NTC-T687K4TRDF	680*	4	25%	27.2	0.3	707
NTC-T105M6.3TRPF	1.0	6.3	10%	0.5	25	32
NTC-T155M6.3TRPF	1.5	6.3	10%	0.5	25	32
NTC-T225M6.3TRPF	2.2	6.3	20%	0.5	20	35
NTC-T225K6.3TRA2F	2.2*	6.3	8%	0.5	18	53
NTC-T225K6.3TRAF	2.2	6.3	4%	0.5	8.0	94
NTC-T335M6.3TRPF	3.3	6.3	20%	0.5	13	44
NTC-T335K6.3TRA2F	3.3*	6.3	8%	0.5	9.0	75
NTC-T335K6.3TRAF	3.3	6.3	4%	0.5	7.5	97
NTC-T475M6.3TRPF	4.7	6.3	20%	0.5	12	29
NTC-T475K6.3TRA2F	4.7*	6.3	8%	0.5	7.5	37
NTC-T475K6.3TRAF	4.7*	6.3	8%	0.5	6.0	41
NTC-T685K6.3TRPF	6.8	6.3	20%	0.5	12	29
NTC-T685K6.3TRA2F	6.8*	6.3	8%	0.5	7.5	37

Note: 20% (M) tolerance parts available special order



STANDARD AND EXTENDED PRODUCT SPECIFICATIONS TABLE

*Extended Case Sizes

Part Number	Cap. (μF)	Voltage (Vdc)	Dissipation Factor @ 120Hz/20°C	Leakage Current (μA) @ 20°C	ESR (ohms) @ 100KHz/20°C	Ripple Current Rating (mA) @ 100KHz/25°C
NTC-T685K6.3TRAF	6.8*	6.3	8%	0.5	5.0	45
NTC-T685K6.3TRBF	6.8*	6.3	6%	0.5	3.5	53
NTC-T106M6.3TRPF	10	6.3	20%	0.63	12	46
NTC-T106K6.3TRA2F	10*	6.3	8%	0.63	10	71
NTC-T106K6.3TRAF	10*	6.3	8%	0.63	4.0	132
NTC-T106K6.3TRBF	10	6.3	6%	0.63	3.0	163
NTC-T156M6.3TRPF	15	6.3	20%	0.95	5.0	71
NTC-T156K6.3TRA2F	15	6.3	12%	0.95	4.0	79
NTC-T156K6.3TRAF	15*	6.3	8%	0.95	3.5	85
NTC-T156K6.3TRB2F	15*	6.3	8%	0.95	3.5	85
NTC-T156K6.3TRBF	15*	6.3	8%	0.95	2.5	100
NTC-T226M6.3TRPF	22	6.3	20%	1.39	4.0	79
NTC-T226K6.3TRA2F	22	6.3	12%	1.39	2.8	134
NTC-T226K6.3TRAF	22*	6.3	10%	1.39	4.5	125
NTC-T226K6.3TRB2F	22*	6.3	12%	1.39	4.5	125
NTC-T226K6.3TRBF	22*	6.3	8%	1.39	2.3	187
NTC-T226K6.3TRCF	22	6.3	6%	1.39	1.8	247
NTC-T336K6.3TRA2F	33	6.3	18%	2.08	3.0	129
NTC-T336K6.3TRAF	33	6.3	12%	2.08	5.0	118
NTC-T336K6.3TRB2F	33	6.3	12%	2.08	1.7	203
NTC-T336K6.3TRBF	33*	6.3	8%	2.08	2.0	200
NTC-T336K6.3TRCF	33*	6.3	8%	2.08	1.8	247
NTC-T476K6.3TRAF	47	6.3	12%	2.96	2.0	187
NTC-T476K6.3TRB2F	47	6.3	12%	2.96	3.0	153
NTC-T476K6.3TRBF	47*	6.3	8%	2.96	2.0	200
NTC-T476K6.3TRCF	47*	6.3	8%	2.96	1.6	262
NTC-T686K6.3TRAF	68	6.3	30%	4.29	2.0	187
NTC-T686K6.3TRB2F	68	6.3	20%	4.29	2.0	187
NTC-T686K6.3TRBF	68*	6.3	10%	4.29	1.8	211
NTC-T686K6.3TRC2F	68	6.3	10%	4.29	0.8	335
NTC-T686K6.3TRCF	68*	6.3	8%	4.29	1.2	303
NTC-T686K6.3TRDF	68*	6.3	8%	4.29	0.8	433
NTC-T107K6.3TRB2F	100	6.3	20%	6.3	1.3	232
NTC-T107K6.3TRBF	100	6.3	12%	6.3	1.2	258
NTC-T107K6.3TRC2F	100	6.3	10%	6.3	0.8	335
NTC-T107K6.3TRCF	100*	6.3	10%	6.3	0.9	350
NTC-T107K6.3TRDF	100	6.3	8%	6.3	0.8	433
NTC-T157K6.3TRBF	150	6.3	12%	9.45	1.0	283
NTC-T157K6.3TRCF	150	6.3	10%	9.45	1.2	303
NTC-T157K6.3TRDF	150*	6.3	8%	9.45	0.7	463
NTC-T227K6.3TRBF	220	6.3	18%	13.9	0.5	400
NTC-T227K6.3TRCF	220	6.3	14%	13.9	1.2	303
NTC-T227K6.3TRVF	220	6.3	12%	13.9	0.5	500
NTC-T227K6.3TRDF	220*	6.3	12%	13.9	0.8	433
NTC-T337K6.3TRVF	330	6.3	14%	20.8	0.5	500
NTC-T337K6.3TRDF	330	6.3	14%	20.8	1.0	387
NTC-T477K6.3TRDF	470	6.3	20%	29.6	0.3	707
NTC-T105M10TRPF	1	10	10%	0.5	25	32
NTC-T155M10TRPF	1.5	10	20%	0.5	25	32
NTC-T155K10TRA2F	1.5*	10	8%	0.5	20	50
NTC-T155K10TRAF	1.5	10	4%	0.5	8.0	94
NTC-T225M10TRPF	2.2	10	20%	0.5	20	35
NTC-T225K10TRA2F	2.2*	10	8%	0.5	12	65
NTC-T225K10TRAF	2.2	10	8%	0.5	5.5	113
NTC-T335M10TRPF	3.3	10	20%	0.5	20	35

Note: 20% (M) tolerance parts available special order



STANDARD AND EXTENDED PRODUCT SPECIFICATIONS TABLE

*Extended Case Sizes

Part Number	Cap. (µF)	Voltage (Vdc)	Dissipation Factor @ 120Hz/20°C	Leakage Current (µA) @ 20°C	ESR (ohms) @ 100KHz/20°C	Ripple Current Rating (mA) @ 100KHz/25°C
NTC-T335K10TRA2F	3.3*	10	8%	0.5	12	65
NTC-T335K10TRAF	3.3	10	8%	0.5	5.5	113
NTC-T475M10TRPF	4.7	10	20%	1.0	10	50
NTC-T475K10TRA2F	4.7*	10	8%	1.0	8.0	79
NTC-T475K10TRAF	4.7*	10	8%	1.0	5.0	118
NTC-T475K10TRBF	4.7	10	4%	1.0	3.5	151
NTC-T685K10TRA2F	6.8	10	8%	0.68	8.0	79
NTC-T685K10TRAF	6.8*	10	8%	0.68	4.5	125
NTC-T685K10TRBF	6.8	10	8%	0.68	3.0	163
NTC-T106M10TRPF	10	10	20%	1.0	6.0	65
NTC-T106K10TRA2F	10	10	8%	1.0	5.0	100
NTC-T106K10TRAF	10*	10	8%	1.0	3.2	148
NTC-T106K10TRB2F	10*	10	8%	1.0	3.2	148
NTC-T106K10TRBF	10*	10	8%	1.0	2.5	179
NTC-T106K10TRCF	10	10	8%	1.0	1.8	247
NTC-T156K10TRA2F	15	10	20%	1.5	3.0	129
NTC-T156K10TRB2F	15*	10	8%	1.5	2.5	167
NTC-T156K10TRCF	15	10	8%	1.5	1.8	247
NTC-T226K10TRAF	22	10	12%	2.2	2.5	167
NTC-T226K10TRB2F	22	10	12%	2.2	4.0	132
NTC-T226K10TRBF	22*	10	8%	2.2	2.4	183
NTC-T226K10TRCF	22*	10	8%	2.2	1.8	247
NTC-T336K10TRB2F	33	10	12%	3.3	1.7	203
NTC-T336K10TRBF	33	10	8%	3.3	2.0	200
NTC-T336K10TRCF	33*	10	8%	3.3	1.6	262
NTC-T336K10TRDF	33*	10	6%	3.3	0.8	433
NTC-T476K10TRBF	47	10	8%	4.7	3.0	163
NTC-T476K10TRC2F	47	10	8%	4.7	1.0	300
NTC-T476K10TRCF	47*	10	8%	4.7	1.6	262
NTC-T476K10TRDF	47	10	8%	4.7	0.8	433
NTC-T686K10TRBF	68	10	12%	6.8	0.9	298
NTC-T686K10TRC2F	68	10	10%	6.8	1.0	300
NTC-T686K10TRCF	68*	10	8%	6.8	1.2	303
NTC-T686K10TRDF	68*	10	8%	6.8	0.8	433
NTC-T107K10TRC2F	100	10	10%	10	0.8	335
NTC-T107K10TRCF	100	10	10%	10	1.2	303
NTC-T107K10TRVF	100	10	8%	10	0.5	500
NTC-T107K10TRDF	100*	10	8%	10	0.7	463
NCT-T157K10TRVF	150	10	8%	15	0.5	500
NTC-T157K10TRDF	150*	10	10%	15	0.7	463
NTC-T227K10TRDF	220	10	12%	22	1.0	387
NTC-T227K10TREF	220*	10	8%	22	0.9	428
NTC-T474M16TRPF	0.47	16	10%	0.5	35	27
NTC-T105M16TRPF	1.0	16	20%	0.5	25	32
NTC-T105K16TRA2F	1.0*	16	6%	0.5	16	56
NTC-T105K16TRAF	1.0	16	4%	0.5	10	84
NTC-T155K16TRA2F	1.5*	16	6%	0.5	13	62
NTC-T155K16TRAF	1.5	16	4%	0.5	8.0	94
NTC-T225M16TRPF	2.2	16	10%	0.5	19	36
NTC-T225K16TRA2F	2.2*	16	6%	0.5	13	62
NTC-T225K16TRAF	2.2	16	6%	0.5	6.0	108
NTC-T335M16TRPF	3.3	16	10%	0.53	8.0	56
NTC-T335K16TRA2F	3.3	16	8%	0.53	7.0	85
NTC-T335K16TRAF	3.3*	16	6%	0.53	5.0	118
NTC-T335K16TRBF	3.3	16	4%	0.53	3.5	151
NTC-T475K16TRA2F	4.7	16	8%	0.75	4.5	105

Note: 20% (M) tolerance parts available special order



STANDARD AND EXTENDED PRODUCT SPECIFICATIONS TABLE

*Extended Case Sizes

Part NuKber	Cap. (µF)	Voltage (Vdc)	Dissipation Factor @ 120Hz/20°C	Leakage Current (µA) @ 20°C	ESR (ohms) @ 100KHz/20°C	Ripple Current Rating (mA) @ 100KHz/25°C
NTC-T475K16TRAF	4.7*	16	6%	0.75	5.0	118
NTC-T475K16TRBF	4.7	16	6%	0.75	3.0	163
NTC-T685K16TRA2F	6.8*	16	6%	1.09	4.5	105
NTC-T685K16TRAF	6.8*	16	6%	1.09	5.0	118
NTC-T685K16TRB2F	6.8	16	6%	1.09	5.0	118
NTC-T685K16TRBF	6.8*	16	6%	1.09	2.5	179
NTC-T106K16TRAF	10	16	8%	1.6	5.0	118
NTC-T106K16TRB2F	10	16	8%	1.6	4.0	132
NTC-T106K16TRBF	10*	16	6%	1.6	2.4	183
NTC-T106K16TRCF	10	16	6%	1.6	1.8	247
NTC-T156K16TRAF	15	16	12%	2.4	5.0	118
NTC-T156K16TRBF	15*	16	6%	2.4	2.5	167
NTC-T156K16TRCF	15*	16	6%	2.4	1.8	247
NTC-T156K16TRDF	15	16	6%	2.4	1.8	289
NTC-T226K16TRB2F	22	16	10%	3.52	2.2	178
NTC-T226K16TRBF	22*	16	6%	3.52	2.5	179
NTC-T226K16TRCF	22*	16	6%	3.52	1.6	209
NTC-T226K16TRDF	22	16	6%	3.52	0.8	296
NTC-T336K16TRBF	33	16	8%	5.28	1.4	239
NTC-T336K16TRC2F	33	16	6%	5.28	1.4	254
NTC-T336K16TRCF	33*	16	6%	5.28	1.2	303
NTC-T336K16TRDF	33*	16	6%	5.28	0.8	433
NTC-T476K16TRCF	47*	16	6%	7.52	1.2	303
NTC-T476K16TRDF	47*	16	6%	7.52	0.8	433
NTC-T686K16TRCF	68	16	6%	10.9	0.7	396
NTC-T686K16TRDF	68*	16	6%	10.9	0.7	463
NTC-T107K16TRDF	100*	16	10%	16.0	1.0	387
NTC-T157K16TRDF	150*	16	6%	24.0	0.9	408
NTC-T684K20TRAF	0.68	20	4%	0.5	12	76
NTC-T105K20TRA2F	1*	20	6%	0.5	13	62
NTC-T105K20TRAF	1*	20	6%	0.5	9.0	88
NTC-T155K20TRA2F	1.5*	20	6%	0.5	13	62
NTC-T155K20TRAF	1.5*	20	6%	0.5	6.5	104
NTC-T225M20TRPF	2.2	20	10%	0.5	8.0	56
NTC-T225K20TRA2F	2.2	20	6%	0.5	7.0	85
NTC-T225K20TRAF	2.2*	20	6%	0.5	6.0	108
NTC-T225K20TRBF	2.2	20	4%	0.5	3.5	151
NTC-T335K20TRA2F	3.3	20	8%	0.66	5.0	100
NTC-T335K20TRAF	3.3*	20	6%	0.66	5.0	118
NTC-T335K20TRB2F	3.3	20	6%	0.66	3.9	134
NTC-T335K20TRBF	3.3*	20	6%	0.66	3.0	163
NTC-T475K20TRA2F	4.7	20	15%	0.94	5.0	100
NTC-T475K20TRAF	4.7*	20	6%	0.94	5.0	118
NTC-T475K20TRB2F	4.7	20	6%	0.94	3.0	153
NTC-T475K20TRBF	4.7*	20	6%	0.94	3.0	163
NTC-T475K20TRCF	4.7	20	4%	0.94	2.4	214
NTC-T685K20TRB2F	6.8	20	6%	1.36	3.0	153
NTC-T685K20TRBF	6.8*	20	6%	1.36	2.8	169
NTC-T685K20TRCF	6.8	20	6%	1.36	1.9	241
NTC-T106K20TRBF	10*	20	6%	2.0	2.5	179
NTC-T106K20TRCF	10*	20	6%	2.0	1.8	247
NTC-T106K20TRDF	10	20	6%	2.0	1.3	340
NTC-T156K20TRCF	15*	20	6%	3.0	1.7	254
NTC-T156K20TRDF	15	20	6%	3.0	0.8	433
NTC-T226K20TRC2F	22	20	6%	4.4	1.4	254
NTC-T226K20TRCF	22*	20	6%	4.4	1.5	271
NTC-T226K20TRDF	22*	20	6%	4.4	0.8	433
NTC-T336K20TRDF	33*	20	6%	6.6	0.8	433
NTC-T476K20TRDF	47*	20	6%	9.4	0.8	433

Note: 20% (M) tolerance parts available special order



STANDARD AND EXTENDED PRODUCT SPECIFICATIONS TABLE

*Extended Case Sizes

Part Number	Cap. (µF)	Voltage (Vdc)	Dissipation Factor @ 120Hz/20°C	Leakage Current (µA) @ 20°C	ESR (ohms) @ 100KHz/20°C	Ripple Current Rating (mA) @ 100KHz/25°C
NTC-T474K25TRAF	0.47	25	4%	0.5	14	71
NTC-T684K25TRAF	0.68*	25	6%	0.5	10	84
NTC-T105M25TRPF	1	25	6%	0.5	8.0	56
NTC-T105K25TRA2F	1	25	6%	0.5	13	62
NTC-T105K25TRAF	1*	25	6%	0.5	8.0	94
NTC-T155K25TRAF	1.5*	25	6%	0.5	8.0	94
NTC-T155K25TRBF	1.5	25	4%	0.5	4.6	132
NTC-T225K25TRAF	2.2*	25	6%	0.55	8.0	94
NTC-T225K25TRBF	2.2	25	6%	0.55	4.0	141
NTC-T335K25TRAF	3.3	25	6%	0.83	7.0	100
NTC-T335K25TRBF	3.3*	25	6%	0.83	3.5	151
NTC-T335K25TRCF	3.3	25	4%	0.83	2.5	210
NTC-T475K25TRB2F	4.7	25	6%	1.18	3.0	153
NTC-T475K25TRBF	4.7*	25	6%	1.18	3.0	163
NTC-T475K25TRCF	4.7	25	4%	1.18	2.4	214
NTC-T685K25TRBF	6.8	25	6%	1.7	2.5	179
NTC-T685K25TRCF	6.8*	25	6%	1.7	1.9	241
NTC-T685K25TRDF	6.8	25	6%	1.7	1.4	327
NTC-T106K25TRC2F	10	25	6%	2.5	2.0	212
NTC-T106K25TRCF	10*	25	6%	2.5	1.8	247
NTC-T106K25TRDF	10	25	6%	2.5	1.2	354
NTC-T156K25TRCF	15	25	6%	3.75	1.5	271
NTC-T156K25TRDF	15*	25	6%	3.75	1.0	387
NTC-T226K25TRDF	22*	25	6%	5.5	0.8	433
NTC-T336K25TRDF	33	25	6%	8.25	0.7	463
NTC-T104K35TRAF	0.1	35	4%	0.5	18	62
NTC-T224K35TRAF	0.22	35	4%	0.5	18	62
NTC-T334K35TRAF	0.33	35	4%	0.5	15	68
NTC-T474K35TRAF	0.47*	35	6%	0.5	12	76
NTC-T474K35TRBF	0.47	35	4%	0.5	8.0	100
NTC-T105K35TRA2F	1	35	6%	0.5	13	62
NTC-T105K35TRAF	1*	35	6%	0.5	8.0	94
NTC-T105K35TRBF	1	35	4%	0.5	4.8	129
NTC-T155K35TRAF	1.5*	35	6%	0.53	8.0	94
NTC-T155K35TRBF	1.5*	35	6%	0.53	4.0	141
NTC-T155K35TRCF	1.5	35	4%	0.53	3.0	191
NTC-T225K35TRAF	2.2	35	6%	0.77	5.0	118
NTC-T225K35TRBF	2.2*	35	6%	0.77	4.2	138
NTC-T225K35TRCF	2.2	35	4%	0.77	3.0	191
NTC-T335K35TRB2F	3.3	35	6%	1.16	3.0	153
NTC-T335K35TRBF	3.3*	35	6%	1.16	4.0	141
NTC-T335K35TRCF	3.3	35	4%	1.16	2.5	210
NTC-T335K35TRDF	3.3	35	4%	1.16	2.0	274
NTC-T475K35TRCF	4.7	35	6%	1.65	2.2	224
NTC-T475K35TRDF	4.7	35	4%	1.65	1.5	316
NTC-T685K35TRCF	6.8*	35	6%	2.38	1.9	241
NTC-T685K35TRDF	6.8	35	6%	2.38	1.3	340
NTC-T106K35TRCF	10	35	6%	3.5	1.5	271
NTC-T106K35TRDF	10	35	6%	3.5	1.0	387
NTC-T106K35TREF	10*	35	6%	3.5	1.0	406
NTC-T156K35TRDF	15*	35	6%	5.25	0.9	408
NTC-T105K50TRCF	1	50	4%	0.5	5.5	141
NTC-T225K50TRDF	2.2	50	4%	1.1	1.8	289
NTC-T335K50TRDF	3.3	50	4%	1.65	1.4	327
NTC-T475K50TRDF	4.7	50	4%	2.35	1.4	327

Note: 20% (M) tolerance parts available special order



DIMENSIONS (mm)

Case Code	Metric Code	English Code	L	W	H	P	a
P	2012	0805	2.0 ± 0.2	1.25 +0.25/-0.2	1.2 MAX.	0.5 ± 0.2	0.9 ± 0.1
A2	3216	1206	3.2 ± 0.2	1.6 ± 0.2	1.2 MAX.	0.8 ± 0.3	1.2 ± 0.1
A	3216	1206	3.2 ± 0.2	1.6 ± 0.2	1.6 ± 0.2	0.8 ± 0.3	1.2 ± 0.1
B2	3528	1411	3.5 ± 0.2	2.8 ± 0.2	1.2 MAX.	0.8 ± 0.3	2.3 ± 0.1
B	3528	1411	3.5 ± 0.2	2.8 ± 0.2	1.9 ± 0.2	0.8 ± 0.3	2.2 ± 0.1
C2	6032	2412	6.0 ± 0.3	3.2 ± 0.3	1.5 MAX.	1.3 ± 0.3	2.2 ± 0.1
C	6032	2412	6.0 ± 0.3	3.2 ± 0.3	2.6 ± 0.4	1.3 ± 0.3	2.2 ± 0.1
V	7343	2916	7.3 ± 0.2	4.3 ± 0.2	2.0 MAX.	1.3 ± 0.3	2.4 ± 0.1
D	7343	2916	7.3 ± 0.2	4.3 ± 0.2	2.9 ± 0.3	1.3 ± 0.3	2.4 ± 0.1
E	7343H	2917	7.3 ± 0.2	4.3 ± 0.2	4.1 ± 0.4	1.3 ± 0.3	2.4 ± 0.1

LEAD-FRAME FORMAT*

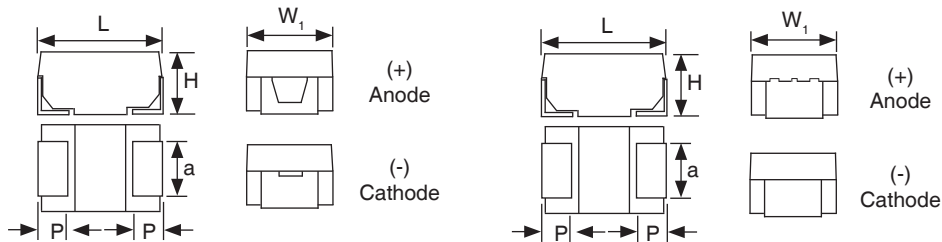

*Parts will be supplied with one of the above lead-frame formats.

Flow/Reflow Soldering
 Maximum Temperature/Time: Flow 260°C/5 Sec.
 Reflow 260°C/10 Sec.

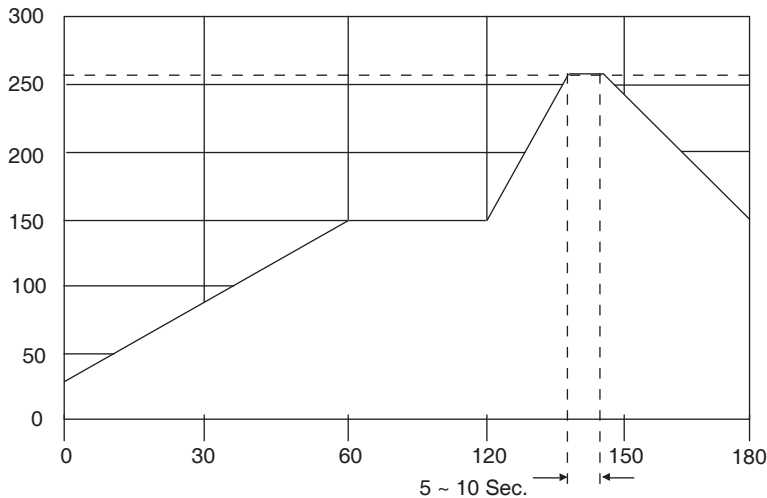

RECOMMENDED LAND PATTERN DIMENSIONS (mm)

Case Size	a	b	c
P	1.05	0.50	1.20
A & A2	1.35	1.10	1.50
B & B2	1.35	1.40	2.70
C	2.00	2.90	2.70
D	2.05	4.10	2.90
D	2.05	4.10	2.90

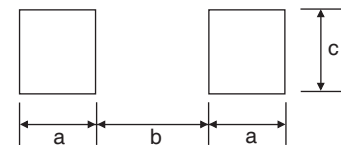

COMPONENT MARKING

P Case Size

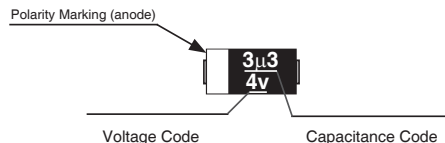
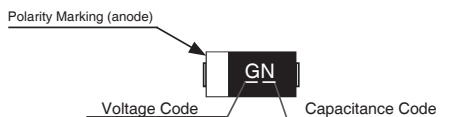

A & A2 Case Size

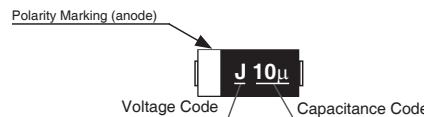
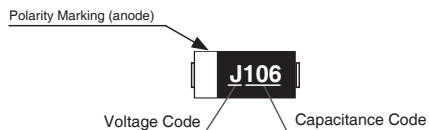

B & B2 Case Size 2.5V marked 2, 6.3V marked 6

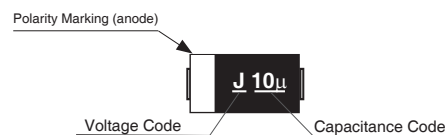
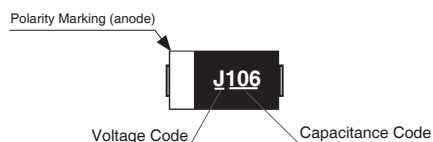

C, V, D & E Case Size 2.5V marked 2, 6.3V marked 6

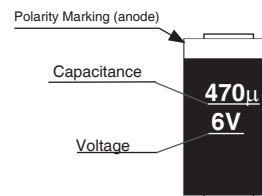
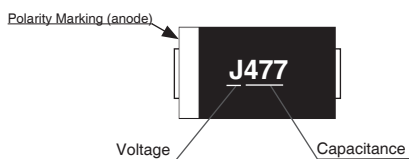

Note: Component body color may be Black (white marking) or Gold (brown marking).

CAPACITANCE CODES

Cap. (μF)	STD EIA Code	EIA Code 198D	Code for P Case Size
0.1	104	A5	-
0.15	154	E5	-
0.22	224	J5	-
0.33	334	N5	N
0.47	474	S5	S
0.68	684	W5	W
1.0	105	A6	A
1.5	155	E6	E
2.2	225	J6	J
3.3	335	N6	N
4.7	475	S6	S
6.8	685	W6	W
10	106	A7	A
22	226	J7	J
33	336	N7	N
47	476	S7	S

VOLTAGE CODES

Voltage	Code
2.5	e
4	G
6.3	J
10	A
16	C
20	D
25	E
35	V
50	H

TAPE DIMENSIONS (mm)

Metric Code	Case Code	$A_0 \pm 0.2$	$B_0 \pm 0.2$	$W \pm 0.3$	$F \pm 0.05$	$P_0 \pm 0.1$	$P_1 \pm 0.1$	$P_2 \pm 0.05$	$G \pm 0.1$	$K \pm 0.2$	T	7" Reel
2012	P	1.4	2.2	8.0	3.5	4.0	4.0	2.0	1.75	1.4	0.2	3000
3216	A2	1.9	3.5	8.0	3.5	4.0	4.0	2.0	1.75	1.4	0.2	3000
3216	A	1.9	3.5	8.0	3.5	4.0	4.0	2.0	1.75	1.9	0.2	2000
3528	B2	3.2	3.8	8.0	3.5	4.0	4.0	2.0	1.75	1.4	0.2	3000
3528	B	3.2	3.8	8.0	3.5	4.0	4.0	2.0	1.75	2.1	0.2	2000
6032	C2	3.7	6.4	12.0	5.65	4.0	8.0	2.0	1.5	1.7	0.3	500
6032	C	3.7	6.4	12.0	5.65	4.0	8.0	2.0	1.5	3.0	0.3	500
7343	V	4.8	7.7	12.0	5.65	4.0	8.0	2.0	1.5	2.4	0.3	500
7343	D	4.8	7.7	12.0	5.65	4.0	8.0	2.0	1.5	3.3	0.3	500
7343H	E	4.7	7.7	12.0	5.5	4.0	8.0	2.0	1.5	4.5	0.6	500

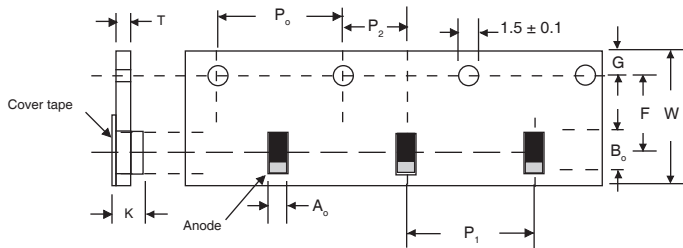

Cover tape peel-off specification

1. Peel-off speed : 300 mm/min.
2. Peel-off force : $F = 30 - 75g$
3. Peel-off angle : $\Theta = 0 - 15^\circ$

Peel-off speed
(F) = 50mm/Sec.

REEL DIMENSIONS (mm)

Tape Width	A	C	D	E	N	W_1	W_2
8mm	178 ± 2.0	13 ± 0.5	21 ± 0.5	2.0 ± 0.5	50 min.	10 ± 2.0	14.5 max.
12mm	178 ± 2.0	13 ± 0.5	21 ± 0.5	2.0 ± 0.5	50 min.	14.5 ± 2.0	18.5 max.

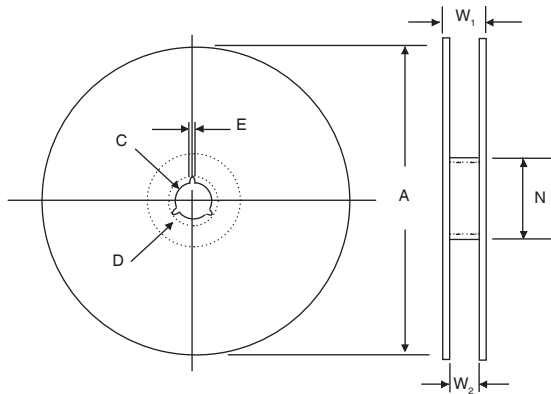
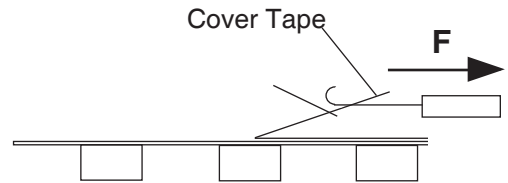

COMPONENT MARKING

P Case Size

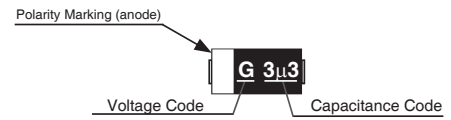
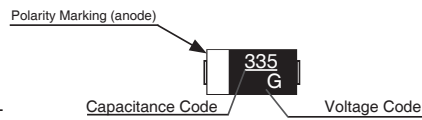
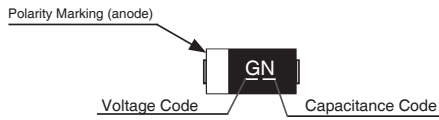

A & A2 Case Size

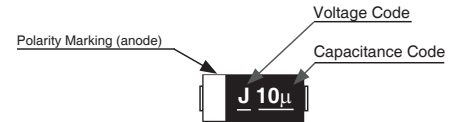
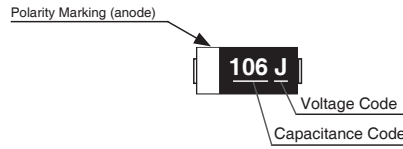
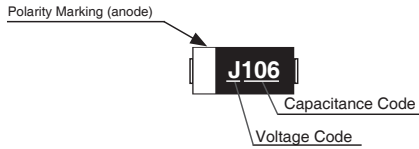

B & B2 Case Size

2.5V marked 2, 6.3V marked 6

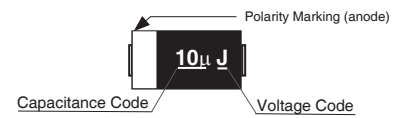
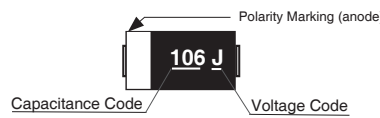
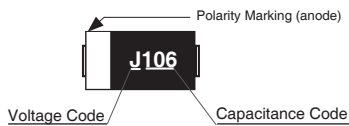

C, V, D & E Case Size

2.5V marked 2, 6.3V marked 6

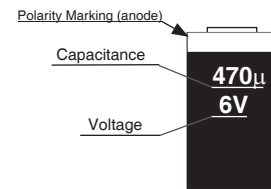
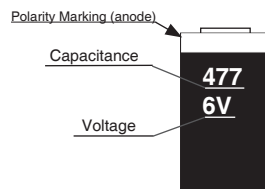
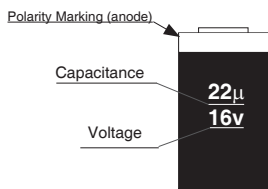

Note: Component body color may be Black(white marking) or Gold (black marking).

CAPACITANCE CODES

Cap. (µF)	STD EIA Code	EIA Code 198D	Code for P Case Size
0.1	104	A5	-
0.15	154	E5	-
0.22	224	J5	-
0.33	334	N5	N
0.47	474	S5	S
0.68	684	W5	W
1.0	105	A6	A
1.5	155	E6	E
2.2	225	J6	J
3.3	335	N6	N
4.7	475	S6	S
6.8	685	W6	W
10	106	A7	A
22	226	J7	J
33	336	N7	N
47	476	S7	S

VOLTAGE CODES

Voltage	Code
2.5	e
4	G
6.3	J
10	A
16	C
20	D
25	E
35	V
50	H

COMPONENT MARKING

P Case Size

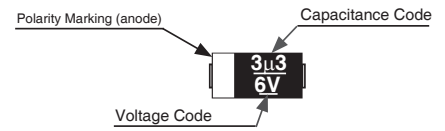
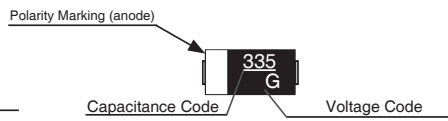
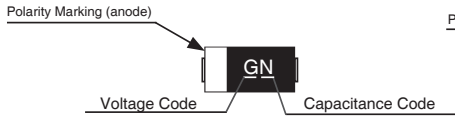

A & A2 Case Size

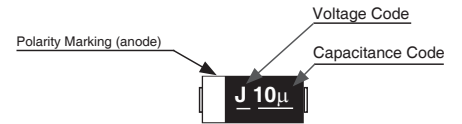
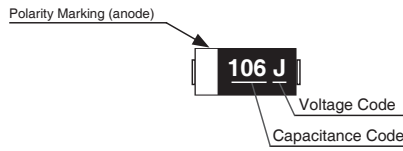
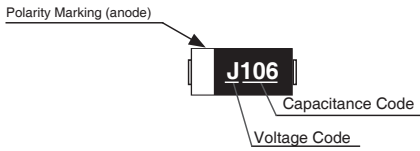

B & B2 Case Size

2.5V marked 2, 6.3V marked 6

