



actual size

SMD Quartz Crystal · JXS32

- 4 pad version, 3.2 x 2.5 mm
- seam sealed ceramic/metal package
- extended temperature ranges available
- high mechanical reliability type available
- for automotive type, see automotive datasheet



RoHS compliant



Pb free



REACH compliant



Conflict mineral free

GENERAL DATA

TYPE	JXS32
frequency range	10.0 ~ 54.0 MHz (fund. AT-cut)
frequency tolerance at 25 °C	± 10 ppm / ± 30 ppm
load capacitance C_L	8/12 pF standard (option: 6 pF ~ 30 pF / series)
shunt capacitance C_0	< 5 pF
storage temperature	-40 °C ~ +90 °C
drive level max.	100 µW
aging	< ± 3 ppm first year (option: < ± 1 ppm first year for tol. ± 10 ppm)

TABLE 1: FREQUENCY STABILITY VS. TEMPERATURE

		± 10 ppm	± 15 ppm	± 20 ppm	± 30 ppm	± 50 ppm	± 100 ppm
-20 °C ~ +70 °C	STD.	○	○	○	○	○	○
-30 °C ~ +85 °C	T(-30/+85)	○	○				
-40 °C ~ +85 °C	T1		○	○	○	○	○
-40 °C ~ +105 °C	T2			○	○	○	○
-40 °C ~ +125 °C	T3					○	○

○ available

ESR (SERIES RESISTANCE RS)

frequency in MHz	vibration mode	ESR max. in Ω	ESR typ. in Ω
10.0 ~ 11.999	fund. - AT	300	150
12.0 ~ 12.999	fund. - AT	100	50
13.0 ~ 15.999	fund. - AT	100	40
16.0 ~ 18.999	fund. - AT	80	40
19.0 ~ 21.999	fund. - AT	60	30
22.0 ~ 29.999	fund. - AT	50	25
30.0 ~ 54.000	fund. - AT	50	20

MARKING

frequency with load capacitance code
company code / date code / internal code

date code: year/month; A ~ M: Jan. - Dec.; example: 8A = 2018 January
7: 2017 8: 2018 9: 2019 0: 2020 1: 2021 2: 2022

Jan.	Febr.	Mar.	Apr.	May	June
A	B	C	D	E	F
July	Aug.	Sept.	Oct.	Nov.	Dec.
G	H	J	K	L	M

DIMENSIONS

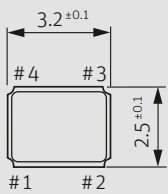

top view

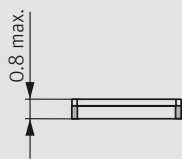

side view

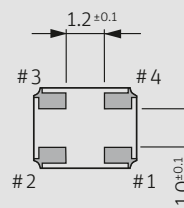

bottom view

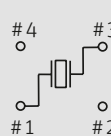

#2-#4: connected to lid, preferably connect to GND crystal connection

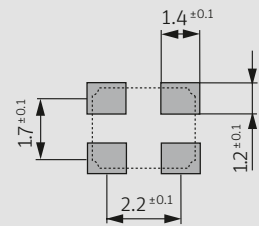

pad layout

in mm

ORDER INFORMATION

Q	frequency	type	load capacitance	tolerance at 25 °C	stability vs. temp. range	option
Quartz	10.0 ~ 54.0 MHz	JXS32	8/12 pF standard 6 pF ~ 30 pF available S for series	10 = ± 10 ppm 30 = ± 30 ppm	10 = ± 10 ppm 15 = ± 15 ppm 20 = ± 20 ppm 30 = ± 30 ppm 50 = ± 50 ppm 100 = ± 100 ppm	blank = -20 °C ~ +70 °C T (-30/+85) = -30 °C ~ +85 °C T1 = -40 °C ~ +85 °C T2 = -40 °C ~ +105 °C T3 = -40 °C ~ +125 °C FU = for fundamental frequencies ≥ 20 MHz HMR = high mechanical reliability (3000g/half sine wave/0.3ms)

Example: Q 28.0-JXS32-12-30/30-T1-FU-LF (Suffix LF = RoHS compliant / Pb free)

SMD Quartz Crystal · JXS32

TAPING SPECIFICATION

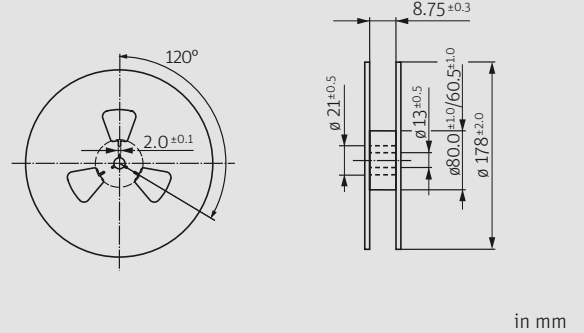
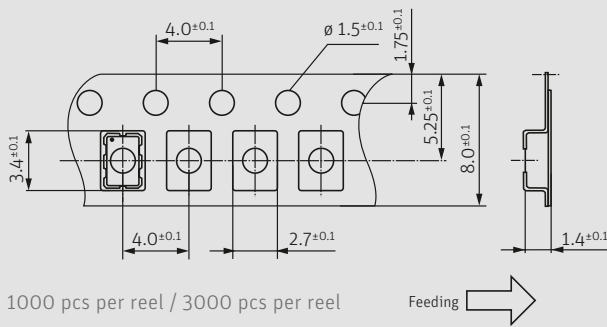

REFLOW SOLDERING PROFILE

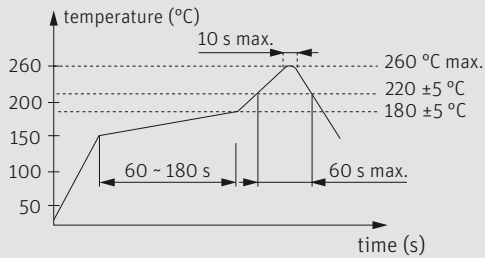

note: parts are also suitable for soldering systems with lead (Pb) content

LOAD CAPACITANCE CODES

8 pF: k	14 pF: x	22 pF: g	series: s
9 pF: n	15 pF: j	24 pF: d	T: 3rd OT
10 pF: h	16 pF: b	25 pF: r	
11 pF: l	17 pF: t	27 pF: w	
12 pF: a	18 pF: f	30 pF: .	
13 pF: v	20 pF: c		

example 20.0 MHz / 12 pF: 20a00