

FEATURES

- ULTRA LOW CAPACITANCE (AS LOW AS 0.8pF)
- EIA SIZES 0402 AND 0603
- MEETS STANDARDS OF IEC 61000-4-2, LEVEL 4
- IDEAL FOR USB2.0, IEEE1394 & HDMI HIGH SPEED DATA APPLICATIONS
- Pb-FREE REFLOW PROCESS COMPATIBLE

**RoHS
Compliant**

includes all homogeneous materials

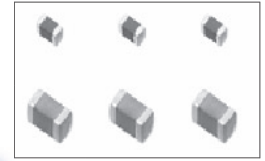

SPECIFICATIONS

*See Part Number System for Details

| Case Size | Part Number | Maximum WVDC | 1mA Voltage (nominal) | Capacitance (pF) | | | Max. Peak Current at 8/20µS, 2 Times | Max. ESD IEC 61000-4-2 | Type | | |
|-----------|--------------------|--------------|-----------------------|------------------|---------|---------|--------------------------------------|------------------------|-----------------------------------|-----------------------|----------------------------|
| | | | | 1MHz | | 1KHz | | | | | |
| | | | | Max. | Typical | Typical | | | | | |
| 0402 | NVT0402H100A800TRF | 10 | 80 | 1 | 0.8 | - | - | Contact discharge 8kV | High Speed, Ultra Low Capacitance | | |
| | NVT0402H5R0B800TRF | 5 | 80 | 2 | 1.5 | - | - | | | | |
| | NVT0402H5R0D500TRF | 5 | 50 | 3 | 2.1 | - | - | | | | |
| | NVT0402H180D800TRF | 18 | 80 | 3 | 2.1 | - | - | | | | |
| | NVT0402H180D171TRF | 18 | 170 | 3 | 2.1 | - | - | | | | |
| 0603 | NVT0603H100A800TRF | 10 | 80 | 1 | 0.8 | - | - | | | | |
| | NVT0603H5R0D500TRF | 5 | 50 | 3 | 2.1 | - | - | | | | |
| | NVT0603H180D800TRF | 18 | 80 | 3 | 2.1 | - | - | | | | |
| 0402 | NVT0603H180D171TRF | 18 | 170 | 3 | 2.1 | - | - | | | Contact discharge 8kV | Low Speed, Low Capacitance |
| | NVT0402S6R7S120TRF | 6.7 | 12 | 220 | 150 | 175 | 10 | | | | |
| | NVT0402S110R180TRF | 11 | 18 | 150 | 120 | 140 | 10 | | | | |
| | NVT0402S130R220TRF | 13 | 22 | 150 | 100 | 116 | 10 | | | | |
| | NVT0402S160L270TRF | 16 | 27 | 47 | 33 | 37 | 10 | | | | |
| | NVT0402S160J270TRF | 16 | 27 | 20 | 15 | 16.5 | 3 | | | | |
| 0603 | NVT0402S300M420TRF | 30 | 42 | 56 | 40 | 45 | 10 | | | | |
| | NVT0603S6R7T120TRF | 6.7 | 12 | 330 | 250 | 290 | 20 | | | | |
| | NVT0603S110S180TRF | 11 | 18 | 220 | 180 | 210 | 20 | | | | |
| | NVT0603S130S220TRF | 13 | 22 | 220 | 160 | 185 | 20 | | | | |
| | NVT0603S160Q270TRF | 16 | 27 | 100 | 85 | 100 | 20 | | | | |
| | NVT0603S160L270TRF | 16 | 27 | 47 | 33 | 37 | 20 | | | | |
| | NVT0603S160J270TRF | 16 | 27 | 20 | 15 | 16.5 | 3 | | | | |
| 0603 | NVT0603S260Q330TRF | 26 | 33 | 100 | 85 | 100 | 20 | | | | |
| | NVT0603S300N420TRF | 30 | 42 | 68 | 55 | 63 | 15 | | | | |

Notes:

1. Maximum Allowable Voltage - max. DC voltage that can be applied continuously within the operating temperature of the part (-40°C ~+85°C).
2. Varistor Voltage - varistor starting voltage between terminals at 1mA DC (also known as the breakdown voltage)
3. Maximum Peak Current - the max. current under the standard pulse 8/20µS, 2 times based on IEC60.
4. Maximum ESD - the max. current under ESD based on IEC 61000-4-2, 10 times (5 times each positive-negative polarity).

PART NUMBERING SYSTEM

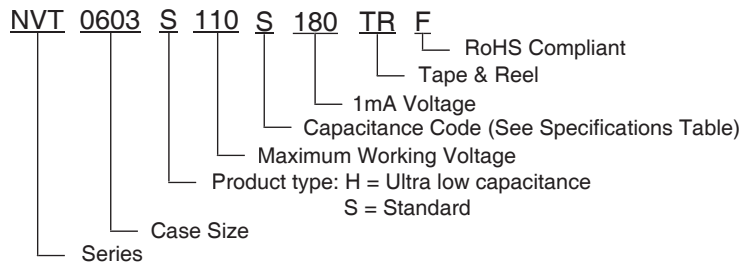

DIMENSIONS (mm)

| Case Size | L | W | T | P |
|-----------|-------------|-------------|-------------|-------------|
| 0402 | 1.00 ± 0.05 | 0.50 ± 0.05 | 0.50 ± 0.05 | 0.20 ± 0.10 |
| 0603 | 1.60 ± 0.10 | 0.80 ± 0.10 | 0.80 ± 0.10 | 0.30 ± 0.20 |

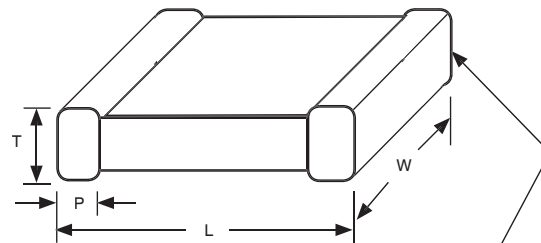

Termination Material: Silver (Ag) base, Nickel (Ni) barrier, 100% Sn finish

RECOMMENDED LAND PATTERN DIMENSIONS (mm)

| Case Size | Reflow Soldering | | |
|-----------|------------------|-----------|-----------|
| | A | B | C |
| 0402 | 0.4 ~ 0.5 | 0.4 ~ 0.5 | 0.4 ~ 0.5 |
| 0603 | 0.8 ~ 1.0 | 0.6 ~ 0.8 | 0.6 ~ 0.8 |

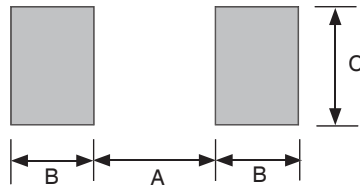

RECOMMENDED REFLOW SOLDERING TEMPERATURE PROFILE

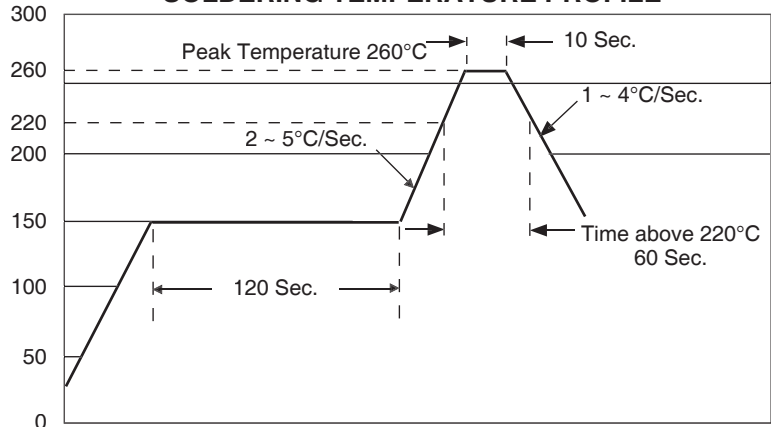

CARRIER TAPE DIMENSIONS (mm)

| Type | A | B | W | F | E | P ₁ | T ₁ | T ₂ | Qty/Reel |
|---------|-------------|-------------|-----------|-------------|-------------|----------------|----------------|----------------|----------|
| NVT0402 | 0.62 ± 0.05 | 1.12 ± 0.05 | 8.0 ± 0.2 | 3.50 ± 0.05 | 1.75 ± 0.10 | 2.00 ± 0.05 | 0.7 max. | 1.0 max. | 10,000 |
| NVT0603 | 1.00 ± 0.10 | 1.80 ± 0.10 | | | | 4.00 ± 0.05 | 1.1 max. | 1.4 max. | 4,000 |

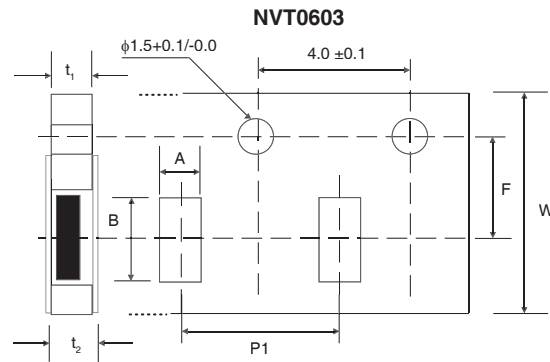
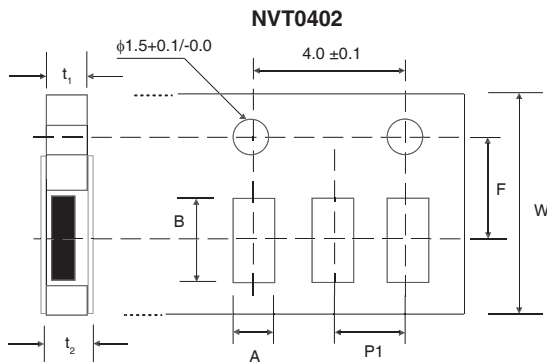

REEL DIMENSIONS (mm)

| A +0/-3 | B +1/-0 | C ± 0.5 | D ± 0.8 | E ± 0.5 | W ± 0.3 |
|---------|---------|---------|---------|---------|---------|
| 180 | 60 | 13 | 21.0 | 2.0 | 9.0 |

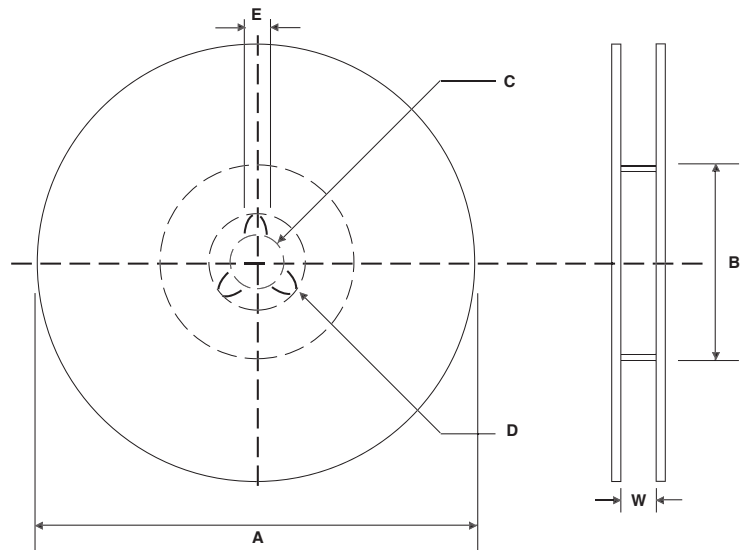

CROSS REFERENCE GUIDE

| NIC P/N | Amotech | AVX | EPCOS | ICT | Littlefuse | Panasonic | TDK |
|--------------------|-------------|--------------|----------------------------|--------------|--------------------------|----------------------------------------------------------|--------------------------------------------------------------------------------------|
| NVT0603S6R7S120TRF | AVL3M03300 | VC06033A100 | - | ICVN1003A100 | V3.5MLA0603 | EZJZ1V120JA | - |
| NVT0402S6R7S120TRF | AVL5M02200 | VC04025X150 | - | ICVN0505X150 | V5.5MLA0402 | EZJZ0V120JA | AVR-M1005C080MTAAB AVR-M1005C080MTABB AVR-M1005C080MTACB |
| NVT0603S6R7S120TRF | AVL5M03300 | VC060305A150 | CN0603M4G | ICVN1005A150 | V5.5MLA0603 | EZJZ1V120KA | AVR-M1608C080MTAAB |
| NVT0402S6R7S120TRF | AVL8M02200 | VC04029X200 | - | ICVN0509X200 | V9MLA0402 V9MLA0402L | EZJZ0V120JA | AVR-M1005C120MTAAB |
| NVT0603S6R7S120TRF | AVL8M03300 | VC060309A200 | CN0603M6G CN0603M7G | ICVN1009A200 | V9MLA0603 | EZJZ1V120KA | AVR-1608C120MT6AB |
| NVT0402S160L270TRF | AVL11L02200 | - | - | - | - | EZJZ0V270EA | - |
| NVT0603S160Q270TRF | AVL11L03300 | - | CN0603L8G | - | - | EZJZ1V270GA | - |
| NVT0402S160L270TRF | AVL14K02200 | VC040214X300 | - | ICVN0514X300 | V14MLA0402 | EZJZ0V270EA | - |
| NVT0603S160Q270TRF | AVL14K03300 | VC060314A300 | CN0603K11G | ICVN1014A300 | V14MLA0603 | EZJZ1V270GA | AVR-M1608C180MT6AB |
| NVT0402S160L270TRF | AVL18K02200 | VC040218X400 | NC0402L14GK2 | - | V18MLA0402 V18MLE0402 | EZJZ0V270EA | - |
| NVT0603S160Q270TRF | AVL18K03300 | VC060318A400 | CN0603K14G | - | V18MLA0603 V18MLE0603 | EZJZ1V270GA | AVR-M1608C220KT6AB AVR-M1608C220KT2AB |
| NVT0402S160L270TRF | - | - | - | ICVN0518X400 | - | EZJZ0V270EA EZJZ0V270RA | AVR-M1005C270MTAAB AVR-M1005C270MTABB |
| NVT0603S160Q270TRF | - | - | CN0603K17G NC0603K17LCG | ICVN1018A400 | - | EZJZ1V270GA EZJZ1V270GA EZJZ1V270EA EZJZ1V270RA | AVR-M1608C270KT6AB AVR-M1608C270KT2AB AVR-M1608C270KTAAB AVR-M1608C270KTABB |
| NVT0603S260Q270TRF | - | VC060325A580 | NC0603K20G | ICVN1026A580 | V26MLA0603 | EZJZ1V330GA | - |

| NIC P/N | EPCOS | AVX | ICT | Panasonic | Littlefuse |
|--------------------|-----------------|----------------|-----|-------------|------------|
| NVT0402H5R0D500TRF | - | - | - | EZJZ0V500AA | - |
| NVT0402H100A800TRF | - | - | - | EZJZ0V80010 | - |
| NVT0603H100A800TRF | - | - | - | EZJZ1V80010 | - |
| NVT0402H100A800TRF | - | VC04AG183R0YA1 | - | EZJZ0V800AA | V0402MHS03 |
| NVT0603H180D800TRF | CM0603V650RFGK2 | VC06AG183R0YA1 | - | EZJZ1V800AA | - |